

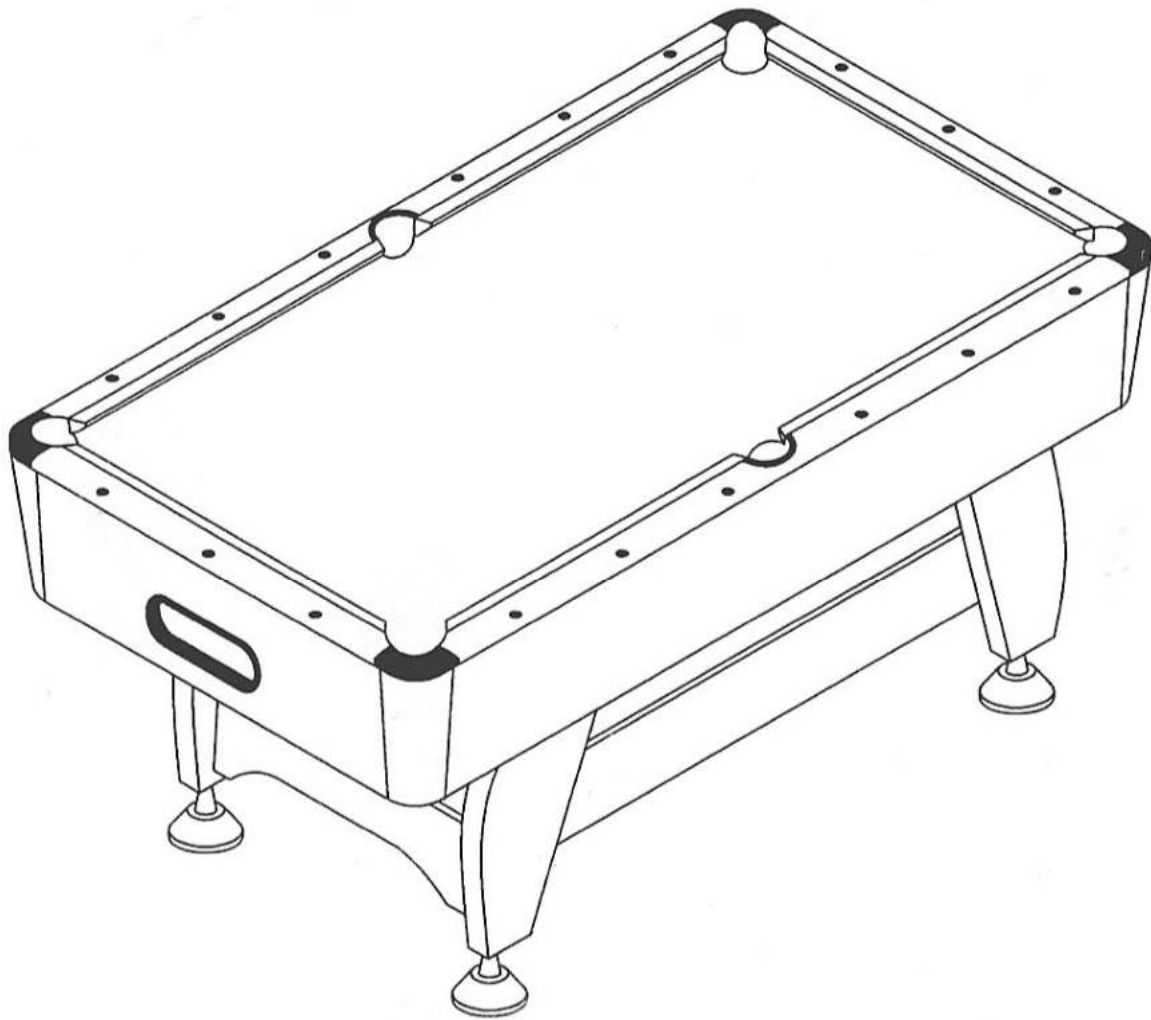

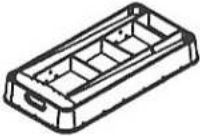









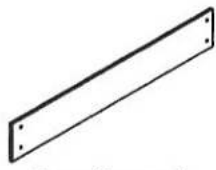
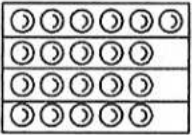
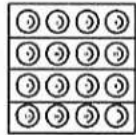
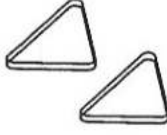



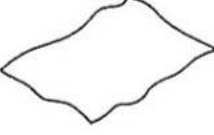

POOL TABLE 8FT

INSTRUCTIONS

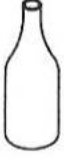
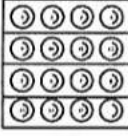
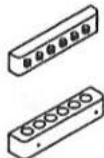

PART LIST

| | | | | |
|--|---|---|---|--|
| <p>#1</p>  <p>Main frame 1 piece</p> | <p>#2</p>  <p>Left leg 2 pieces</p> | <p>#3</p>  <p>Right leg 2 pieces</p> | <p>#4</p>  <p>Leg end panels 2 pieces</p> | <p>#5</p>  <p>Leg side panels 2 pieces</p> |
| <p>#6</p>  <p>Snooker balls 1 set</p> | <p>#7</p>  <p>Billiard ball 1 set</p> | <p>#8</p>  <p>Triangle 2 pieces</p> | <p>#9</p>  <p>Chalk 2 pieces</p> | <p>#10</p>  <p>Cue stick 4 pieces</p> |
| <p>#11</p>  <p>Cue stick A 1 piece</p> | <p>#12</p>  <p>Cue stick B 1 piece</p> | <p>#13</p>  <p>Dust cover 1 piece</p> | <p>#14</p>  <p>Leg leveler 4 pieces</p> | <p>#15</p>  <p>Tool 1 piece</p> |
| <p>#16</p>  <p>Brush 1 piece</p> | <p>#17</p>  <p>5/16" Bolt 12 pieces</p> | <p>#18</p>  <p>5/16" Washer 12 pieces</p> | <p>#19</p>  <p>1/4" Bolt 8 pieces</p> | <p>#20</p>  <p>1/4" Bolt 8 pieces</p> |
| <p>#21</p>  <p>1/4" Washer 16 pieces</p> | <p>#22</p>  <p>Scoreboard 1 piece</p> | <p>#23</p>  <p>Shake flask 1 piece</p> | <p>#24</p>  <p>Billiard ball 1 set</p> | <p>#25</p>  <p>Cue rack 1 set</p> |

Step 1

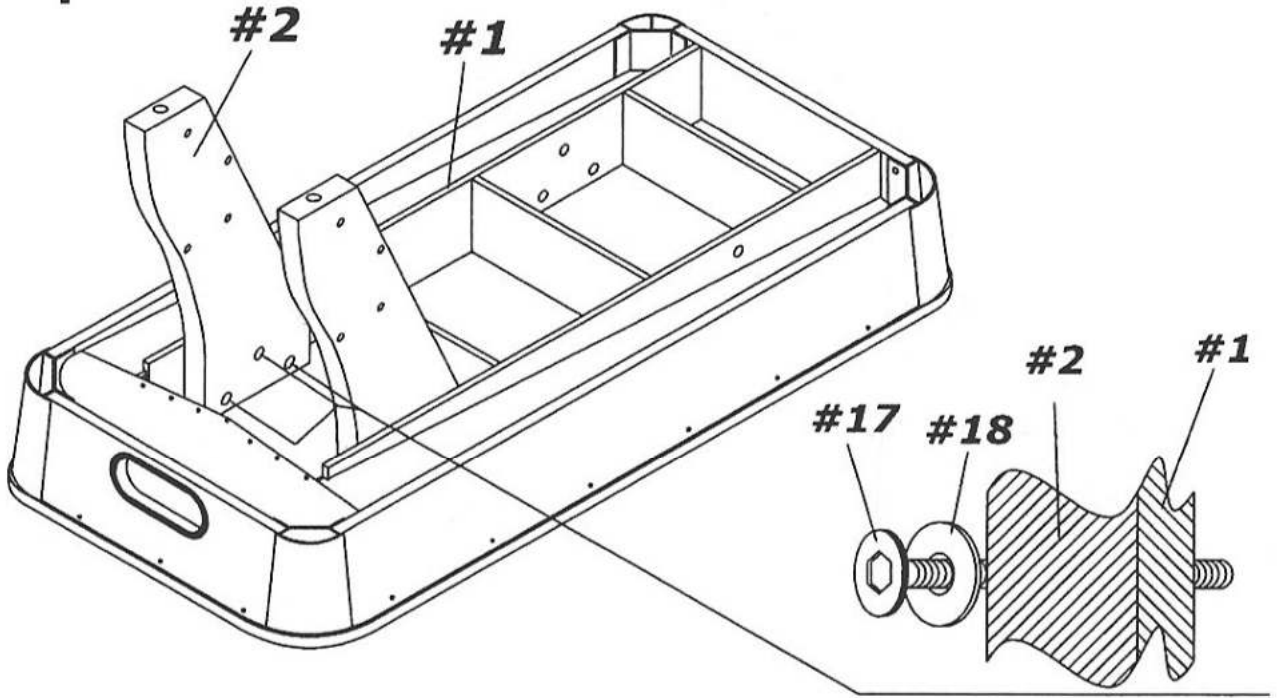

Step 2

